



Decoratieve verlichting/ Lichtketting

LED Lichtketting 100



230~ 24~	Trafo incl.		IP44
 incl.		LED 100 Stk.	 1,1

Lengte toevoerleiding: 1 m met 230V stekker.
Lengte ketting: 10 m
Kop-Ø: 3 mm

LED Lichtketting 100	
wit	226801
blauw	226807
	49,90 €

Kabel zwart



LED Twinkle-Light Lichtketting



230~ 24~	Trafo incl.		IP44
LED 75 Stk.	8 prog.	Control- ler incl.	 0,65

Lengte toevoerleiding: 5 m met 230V stekker
Lengte ketting: 6 m

LED Twinkle Light	
wit	226781
blauw	226787
	39,90 €



Expand Master LED Lichtketting

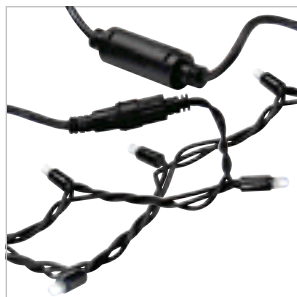

230~			IP44
 incl.	toe- voer- leiding L: 1,5 m	LED 100 Stk.	 0,95

Lengte ketting: 10 m

Expand Master Licht-ketting 100 LED, 10 m	
wit	225221
blauw	225227
	79,90 €

Totaal vermogen 7,7W

Accessoires: Expand Slave-Lichtketting. Aansluiting van max. 9 lichtkettingen mogelijk. Aansluitconnector aan het einde van de Master-lichtketting.



Expand Slave LED Lichtketting



230~			IP44
 incl.		LED 100 Stk.	 0,9

Lengte ketting: 10 m

Expand Slave Licht-ketting 100 LED, 10 m	
wit	225231
blauw	225237
	69,50 €

Totaal vermogen 7,7W

Voor uitbreiding van de Expand Master lichtketting. Aansluiting van max. 9 lichtkettingen mogelijk. Aansluitconnector aan het einde van de Master lichtketting.



Expand LED Lichtophanging

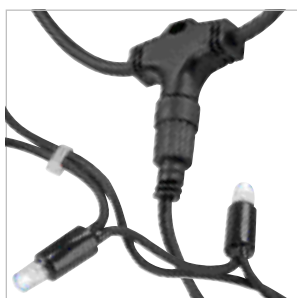

230~			IP44
 incl.	toe- lei- ding L: 1,5 m	LED 300 Stk.	 2,4

L/H: 200/160 m

Expand Licht-ophanging 300 LED	
12x25 LED wit	225241
	199,00 €

Totaal vermogen 45,5W
Lichtophanging 2 m lang met 12 uitgangen à 1,6 m.
Max. 10 lichtophangingen kunnen met een voeding toepassen.





LED Starlight 5 cm

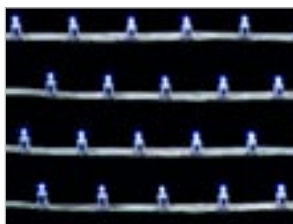

12~	Trafo excl.		
	1,84W incl.	LED 1000 Stk. per m	1,85
Lengte rol: 50 m B/H: 1,2/2 cm			

LED Starlight 5 cm Afstand wit	220001
	14,90 €/m
per LED 20mA.	
Afname alleen in 50 meter rollen.	
Reserve-LED Stk.	50
	591281
	29,90 €

Opmerking: Gebruik alleen met conventionele trafo's!

LED Starlight 10 cm

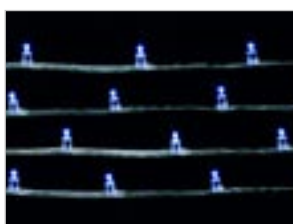

12~	Trafo excl.		
	0,92W incl.	LED 500 Stk. per m	1,5
Lengte rol: 50 m B/H: 1,2/2 cm			

LED Starlight 10 cm Afstand wit	220011
	9,90 €/m
Per LED 20mA.	
Afname alleen in 50 meter rollen.	
Reserve-LED Stk.	50 Stk.
	591281
	29,90 €

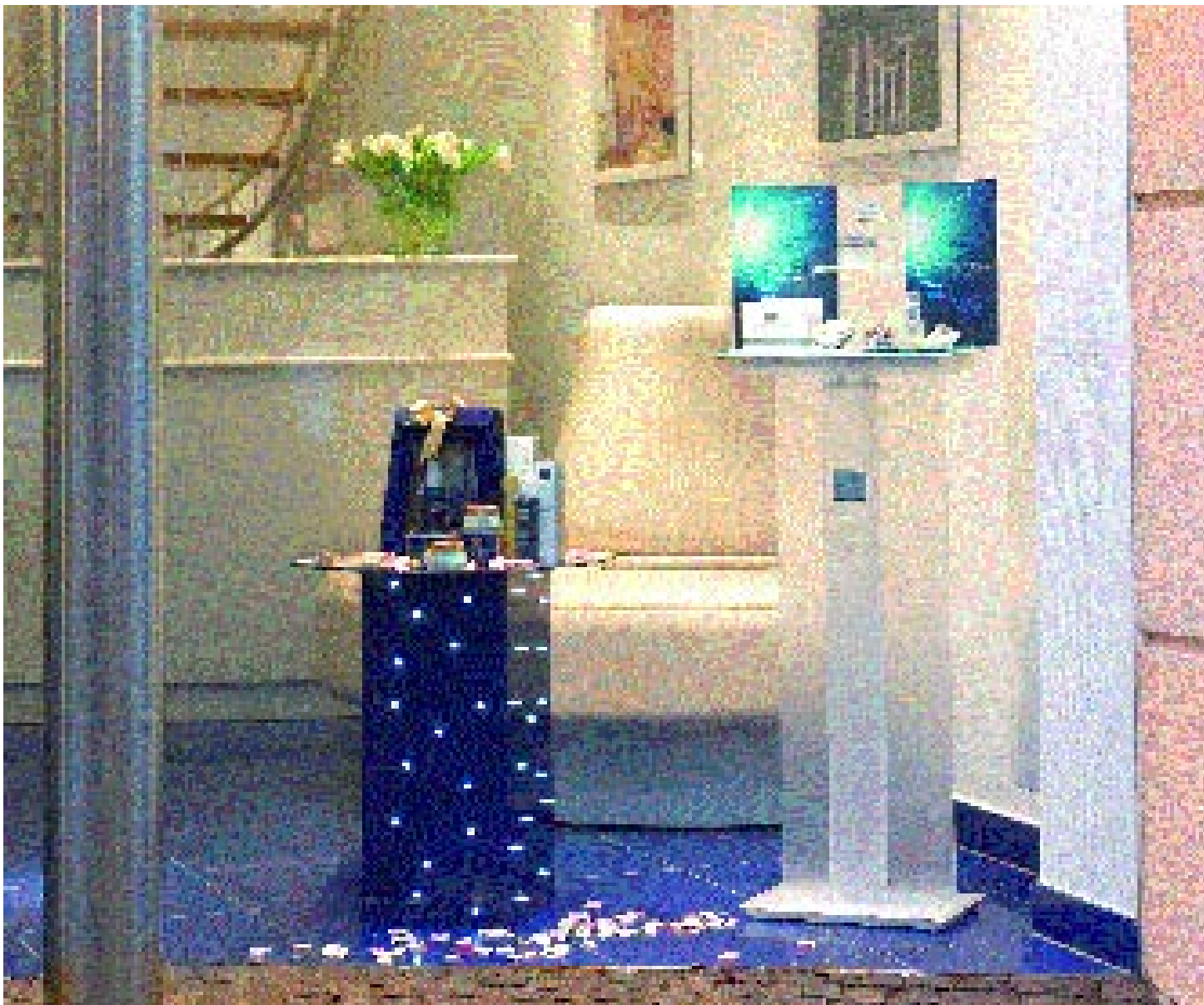

Multi LED Kit met stekker



12~	Trafo en verdel-er		
eind- kapjes incl.	12 LEDs per string		0,01
Totaal-L: 1,6 m Kop-L/Ø: 3,3/1 cm			

Multi LED Kit LED 5 mm met stekker	
12 witte LEDs	631201
12 groene LEDs	631205
12 blauwe LEDs	631207
	29,90 €
12 gele LEDs	631204
12 rode LEDs	631206
	24,90 €
Alleen met trafo en verdeel- kit 631200 te gebruiken!	

436



Trafo en verdeler voor Multi LED Kit



230~	6 voud. verdel-er		
18VA	toelei- ding prim.		0,1
L/B/H: 8,5/7/5,5 cm			

Trafo en verdeelblok	
	631200
	29,90 €
Trafo en verdeler voor maximaal 6x 12 LEDs (zie bovenstaande keuze). Inbouwmaat voor montage met	

Ledi Light®
Fiber Set LED



Kop-L/Ø: 3,3/1 cm

230~ 6~	Trafo incl.		
		0,8	2,5
	Ader-Ø 0,086	Eind- kapjes incl.	0,89

Fiber Set LED
631100
129,00 €

Ook zonder eindkappen te monteren; Inbouwmaat is voor montage met eindkappen..

80 ca. 2 m fiberaders, die via een 4-kanaals generator, gebaseerd op LED techniek, van het benodigde licht voorzien worden. 80 transparante, kegelvormige kunststof eindkappen en een geschikte netadapter incl. prim.: 230V/50Hz sek.: 6V/250HZ

Mini LED
Module - Ketting



12V=	Net- voed- excl.		IP55
	25 mod- ules	PC+ kunst- hars	0,35

L: 2,88 m
Module-L/B/H: 5/1,1/0,9 cm

In te korten na elke module. Max. 4 kettingen achter elkaar te mon-

Mini LED Module -ketting
25x 3 Superflux LED wit,
6W totaal 550401
139,00 €
geel, 9W totaal 550404
groen,6W totaal 550405
rood, 9W totaal 550406
blauw,6W totaal 550407
129,00 €
75 Superflux LED

RGB Mini LED
Module-Ketting
3in1



12V=	Net- voed- excl.		IP55
			contr. excl.
	25 mod- ules	PC+ Kunst- hars	0,35

L: 2,88 m

RGB Mini LED Modul-
Ketting 25x 3 Superflux
3in1 LED
RGB
550403
129,00 €
75 Superflux 3in1 RGB-
LED
Totaal vermogen 15W

In te korten na elke module.
Max. 3 kettingen achter elkaar te

Netvoeding voor
Mini LED-Module-
Ketting 12W



230~ 12V=			
	KEMA RELIFE		0,06

Netvoeding voor Mini
LED-Modul-Ketting 12W
12V, 12W 470507
24,90 €

L/B/H: 8,5/4/2,3 cm

Netvoeding voor
Mini LED-Module
- Ketting 60W



230~ 12V=			
	KEMA RELIFE		0,62

Netvoeding voor Mini-
LED-Modul-Ketting 60W
12V, 60W 470508
119,00 €

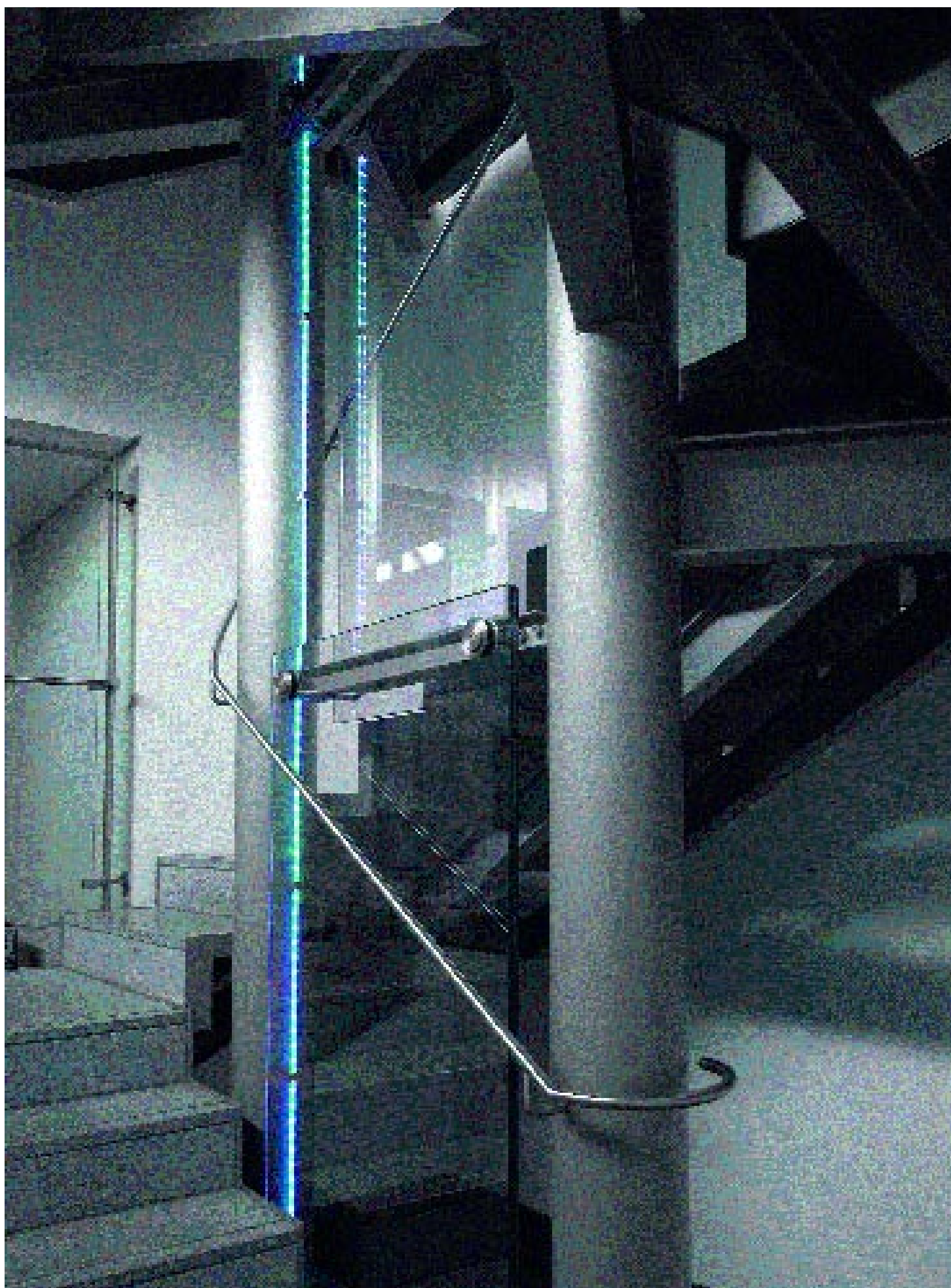

LED PenLight® Pro
230V/10,5 m



LED-Afstand: 27,7 mm
In te korten elke 1,5 m
Vermogen: 4,6W/1,5 m
LEDs per 1,5 m: 54 Stk.
Ø: 13 mm/Lengte: 10,5 m

230~			IP44
			1,8

LED PenLight® Pro
230V, 10,5 m
rond, wit 232711
rond, blauw 232717
169,00 €

Incl. aansluitset met 1,5 m toevo-
erleiding.

LED PenLight® Pro
230V/40,5 m



LED-Afstand: 27,7 mm
In te korten elke 1,5 m
Vermogen: 4,6W/1,5 m
LEDs per 1,5 m: 54 Stk.
Ø: 13 mm/Lengte: 40,5 m

230~			IP44
			6,4

LED PenLight® Pro 230V,
40,5 m
rond, wit 232741
rond, blauw 232747
679,00 €

Incl. aansluitset met 1,5 m toevo-
erleiding.

Aansluitset voor
LED PenLight® Pro



230~			IP44
Ø/L: 1,3/7,5 cm, Toeleiding: 1,5 m			

Aansluitset voor LED
PenLight® Pro 230V
helder 232700
5,95 €

Incl. eindkap en lijm.
IP44 na verlijming.
Incl. gelijkrichter.

PenLight® 230V
Ø 13 mm/10 m

Lampenafstand: 27,5 mm
in te korten na 36 Lampen (1
meter)
360 Lampen / 10 m Lengte
Stroom: 0,7A

230~			IP44
			2,2

PenLight®
230V, 10 m
helder 232310
geel 232314
groen 232315
rood 232316
blauw 232317
29,90 €

Incl. aansluitset.

PenLight® 230V
Ø 13 mm/40 m

Lampenafstand: 27,5 mm
in te korten na 36 Lampen (1
meter)
1440 Lampen / 40 m Lengte
Stroom: 2,8A



230~			IP44
			7,6

PenLight®
230V, 40 m
helder 232340
geel 232344
groen 232345
rood 232346
blauw 232347
99,00 €



Incl. aansluitset.

Decoratieve verlichting/ PenLight®

Aansluitset

	230~			IP44	Aansluitset 230V incl. eindkap 232611 9,90 € Voor PenLight® 230V. IP44 na afdichting met zuurvrije silicone-kit.
	Ø/L: 3/7 cm, Toeleiding: 1,5 m				

Doorverbinder

	230~			IP44	Doorverbinder 232641 4,40 € Voor LED PenLight® Pro 230V en PenLight® 230V. IP44 na afdichting met zuurvrije silicone-kit.
	Ø/L: 2,6/6,7 cm				

Dakgootclips

					Dakgootclips 10 Stk. 232681 7,90 € Voor LED PenLight® Pro 230V en PenLight® 230V.

Bevestigingsclips

					Bevestigingsclips 100 Stk. 232651 23,50 € Voor LED PenLight® Pro 230V en PenLight® 230V.

440

Eindkappen

					Eindkappen 232691 0,36 € Voor LED PenLight® Pro 230V en PenLight® 230V. IP44 na afdichting met zuurvrije silicone-kit.

PenLight® profiel

					PenLight® profiel 1 m 232661 3,60 € Voor LED PenLight® Pro 230V en PenLight® 230V.
	B/H 1,6/1,1 cm				



LED

Montage voorbeeld: LED Strips, wit, Art.-Nr. 550181,
Montage met Bevestigingsclips, Art.-Nr. 550191.
"Tunnel"-Effect door meervoudige spiegeling.

Design by Mucke-Manufaktur.

Decoratieve verlichting/ LED Strips, single colour



Trafo Lichtkleuren



max. lengte strips in cm

Trafo Lichtkleuren

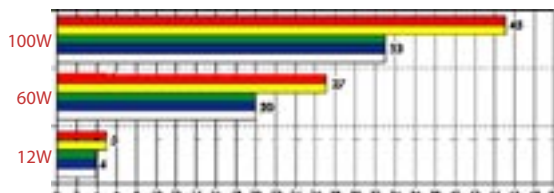

Aantal strips

Gedetailleerde technische informatie over het thema LED Strips zijn op aanvraag te verkrijgen!

LED Strips



L/B/H: 30,5/0,7/0,7 cm

Opmerking: Bij een vermogen >50W moeten de strips opnieuw gevoed worden. 24V DC netvoeding zie pag. 445.

LED Strip met 24 LED in te korten elke 7,6 cm
 wit 3W/strip 550181
 warm-wit 3W/strip 550182
 groen 3W/strip 550185
 blauw 3W/strip 550187
 29,90 €

geel 2,2W/strip 550184
 rood 2,2W/strip 550186
 19,90 €



442

Aansluitkabel

voor single colour LED Strips

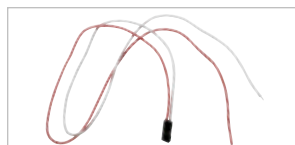

L: 50 cm

Aansluitkabel voor single colour LED strips 2 Stk. 550192
 2,98 €

Verbindings-stekker

voor single colour LED Strips



L: 10 cm

Verbindingsstekker voor single colour LED strips 10 Stk. 550190
 7,90 €

Bevestigingsclips

voor single colour LED Strips







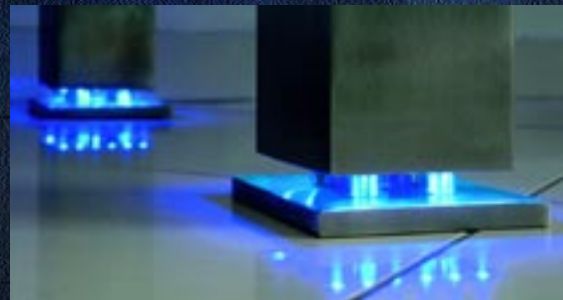
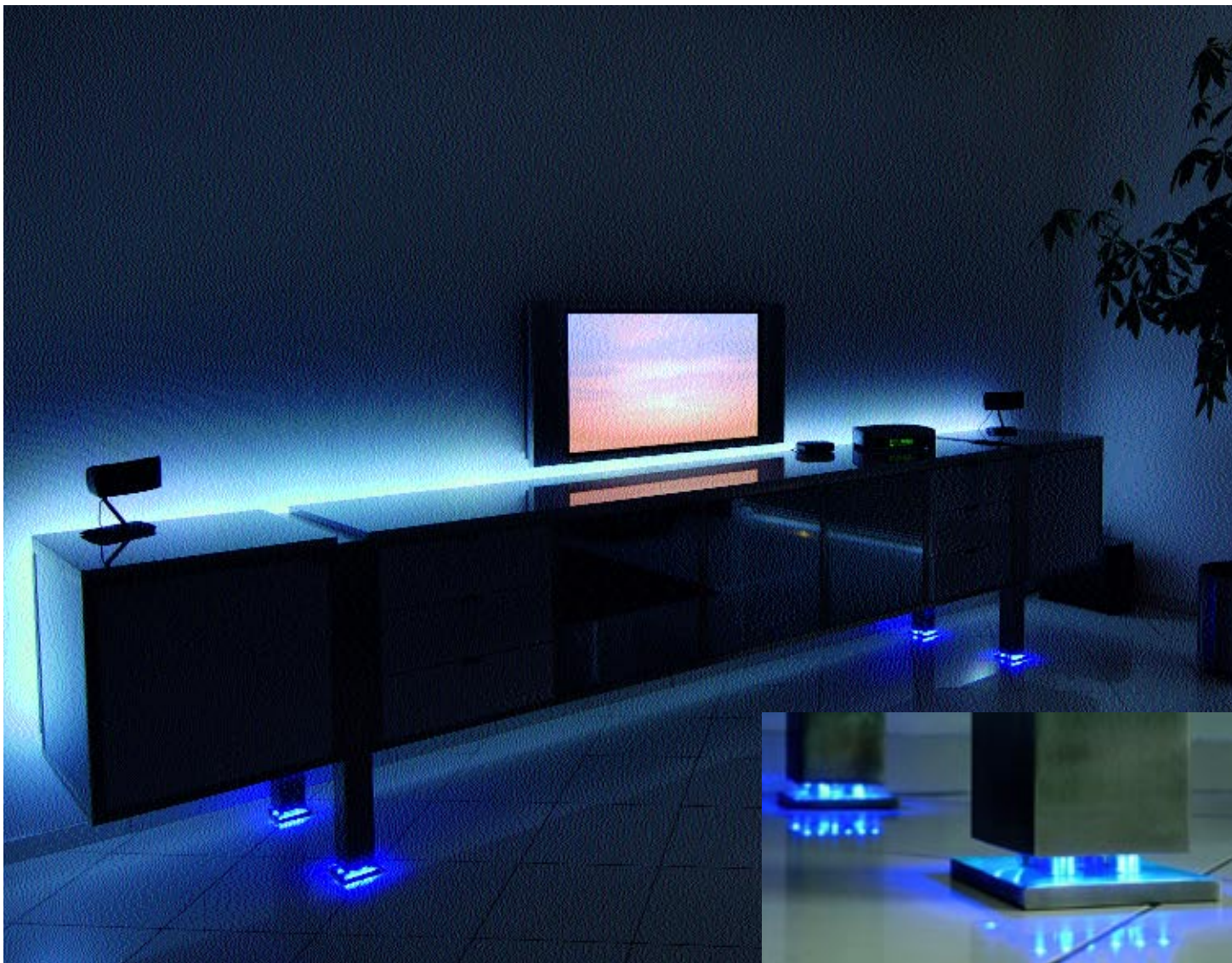

Bevestigingsclips voor single colour LED strips 100 Stk. 550191
 23,50 €





LED Multiflex Strips

	24V=   	Net-voed-excl.  	LED 48 St.	LED Multiflex Strips wit 5,2W/Strip 550231 warmwit 5,2W 550232 groen 3,6W/Strip 550235 blauw 3,6W/Strip 550237 59,50 € geel 4W/Strip 550234 rood 4W/Strip 550236 39,90 € Strip-Lengte 61 cm; in te korten elke 7,6 cm. Minimale buigradius: 1,3 cm 24V Netvoeding voor LED Multiflex Strips vind u op pagina
	L/B/H: 61/0,7/0,26 cm	Verwerking bijvoorbeeld met dubbelzijdige tape transparant, 9 mm 3 m 220000 9,90 €	Aansluiting en verbinding van enkele Flex Strips door middel van soldering! Bij een vermogen >50W moeten de strips opnieuw gevoed worden!	
Gedetailleerde technische informatie over het thema LED Strips zijn op aanvraag te verkrijgen!	LED Multiflex Strips zijn goed geschikt voor montage in PVC-buis en traptredenprofiel. (zie ook pag. 445). 			

Decoratieve verlichting/ LED Strips, single colour

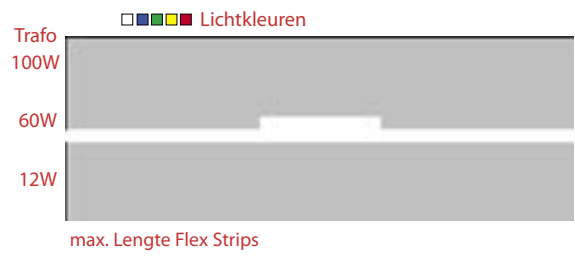
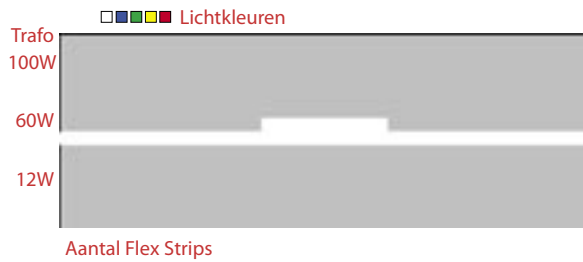

Traptredenprofiel



←	↓	Alu	

Traptredenprofiel
alu/zilver, geano. 213302
alu/goud, geano. 213303
17,90 €/m

Voor montage van LED Strips in PVC buis. Levering alleen in 2 m of 4 m stukken mogelijk.

PVC Buis



		PC	
B/H: 1/1 cm			

PVC Buis
211200
2,40 €/m

Voor montage van LED Strips in traptreden profiel. Levering alleen in 2 m of 4 m stukken

Netvoeding voor LED Strips 12W



230~ 24V=	VA 1-12		
			0,06

Netvoeding voor LED Strips
24V, 12W 470502

L/B/H: 8,5/4/2,3 cm

Netvoeding voor LED Strips 60W



230~ 24V=	VA 1-60		
			0,3

Netvoeding voor LED Strips
24V, 60W 470506

L/B/H: 17,5/7,8/3,5 cm

Netvoeding voor LED Strips 100W



230~ 24V=	VA 1-100		
			0,62

Netvoeding voor LED Strips
24V, 100W 470500
129,00 €

L/B/H: 18,2/8,8/3,5 cm

Decoratieve verlichting/ LED Strips, multi colour

RGB LED Strips 3 in1

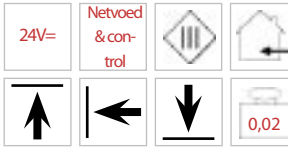

L/B/H: 25/1,6/0,6 cm
Totaal vermogen: 2,6W

RGB LED Strips, 3 in1
10 RGB-LED 3in1, 25 cm
550225
39,90 €

Stuurbaar met 24V= controler bijv.: Easy LIM Controller zie

3 in1 techniek voor optimale lichtmenging!

Opmerking: Bij een vermogen >50W moeten de strips opnieuw gevoed worden.

RGB LED Strips

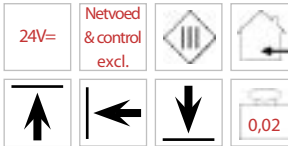
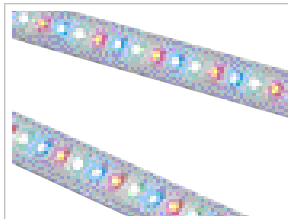

L/B/H: 25/1,6/0,6 cm
Totaal vermogen: 2,65W

RGB LED Strips
met 30 LED, 25 cm
550220

34,90 €

Stuurbaar met 24V= controler bijv.: Easy LIM Controller zie



446



Aantal RGB Strips

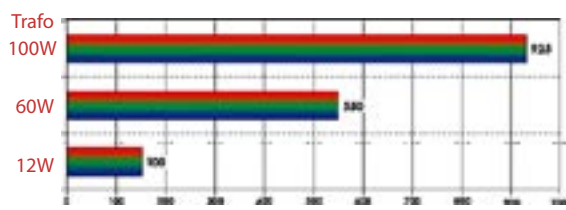

max. Lengte RGB Strips



Verbinder
voor RGB LED Strips

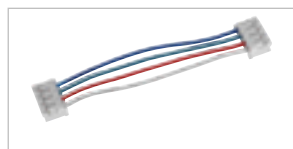

	max. 50VA		
			Lengte: 5 cm

Verbinder
voor RGB LED Strips
10 Stk. 550222
7,90 €

Directverbinder
voor RGB LED Strips



	max. 50VA		

Directverbinder
voor RGB LED Strips
10 Stk. 550224
14,90 €

Aansluitkabel voor
RGB LED Strips



	max. 50VA		
			Lengte: 50 cm

Aansluitkabel
voor RGB LED Strips
2 Stk. 550223
3,45 €

Montageprofiel
voor RGB LED Strips



		Kunst- stof	

Montageprofiel
voor RGB LED Strips
1 m 220631
3,45 €

Montage met direct-
verbinders voor strips!

Bevestigingsclips
voor RGB LED Strips



		Kunst- stof	

Bevestigingsclips
voor RGB LED Strips
100 Stk. 550191
23,50 €



448

LED Strips Outdoor 100, Superflux



24V=			IP55	LED Strips Outdoor 72 SuperFlux LED, 100 cm wit 229811 warmwit 229812 blauw 229817 229,00 €
Netvoeding excl.	excl.	Alu/ Kunststof	 0,7	
L/B/H: 100/2,5/1,5 cm Toevoerleiding: 10 cm Vermogen: 6W/Strip Stralingshoek: 60°				Strips in aluprofiel, in kunsthars gegoten met elk een stekker en contra stekker! Stuurbaar met controller en Netvoeding 24V= zie pag. 453 en 456.

RGB LED Strips Outdoor 25



24V=			IP55
Netvoed-excl.	excl.	Alu/Kunststof	0,18
L/B/H: 25/2,5/1,5 cm Toevoerleiding: 10 cm Vermogen: 2,65W/strip			

RGB LED Strips Outdoor
30 LED/25 cm
▼ 229800
79,90 €
Strips in Aluprofiel, in kunsthar-
gegoten met elk een stekker en
contra stekker!
Stuurbaar met interface en
netvoeding 24V= zie pagina 453
en 456.

RGB LED Strips Outdoor 100



24V=			IP55
Netvoed-excl.	excl.	Alu/Kunststof	0,72
L/B/H: 100/2,5/1,5 cm Toevoerleiding: 10 cm Vermogen: 10,6W/strip			

RGB LED Strips Outdoor
120 LED/100 cm
▼ 229801
199,00 €
Strips in Aluprofiel, in kunsthar-
gegoten met elk een stekker en
contra stekker!
Stuurbaar met interface en
netvoeding 24V= zie pagina 453
en 456.

LED Strips Outdoor 100 RGB 3 in1



24V=			IP55
Netvoed-excl.	excl.	Alu/Kunst-hars	0,7
L/B/H: 100/2,5/1,5 cm Toevoerleiding: 10 cm Vermogen: 10,5W/Strip Stralingshoek: 120° Bedrijfstemperatuur: -5° tot + 50°			

LED-Strips Outdoor 100
RGB 3 in1
40 RGB LED 3in1/100 cm
229813
275,00 €
Strips in Aluprofiel, in kunsthar-
gegoten met elk een stekker en
verbinding!
Stuurbaar met interface en
netvoeding 24V= zie pagina 453
en 456.

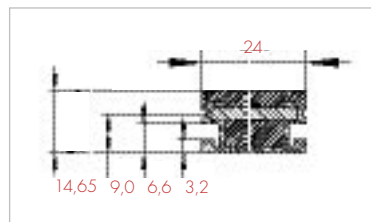

Bevestigingsclip V2A



Bevestigingsclip V2A
voor alle LED Strips
Outdoor
25 Stk. 229802
9,90 €

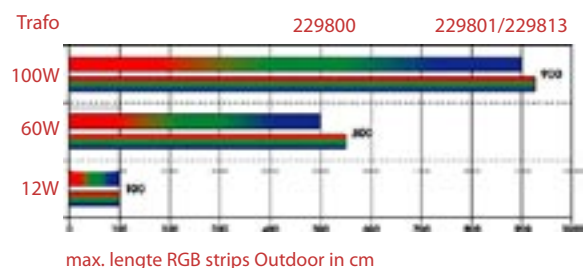
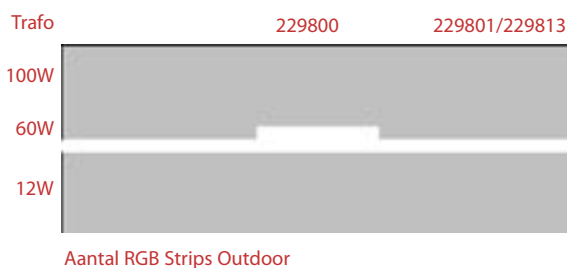

Decoratieve verlichting/ LED Strips, Outdoor

Aansluitkabel

 voor 229800, 229801 en 229813	24V=			IP65	Aansluitkabel voor: RGB Strips Outdoor 229800, 229801, 229813 5 polig 229803
		max. 50VA			
L: 5 m					
 voor 229811, 229812 en 229817	24V=			IP65	Aansluitkabel voor: Strips Outdoor Super Flux 229811, 229812, 229817 4 polig 229821
		max. 50VA			

Verbindingskabel

 voor 229800, 229801 en 229813	24V=			IP65	Verbindingskabel voor: RGB Strips Outdoor 229800, 229801, 229813 5polig 229804
		max. 50VA			
L: 1 m					
 voor 229811, 229812 en 229817	24V=			IP65	Verbindingskabel voor: Strips Outdoor, Super Flux 229811, 229812, 229817 4polig 229820
		max. 50VA			

Aansluitschema 5-polig:

wit+Zwart=(+) Groen=Groen Bruin=Rode LED Blauw=Blauwe	Let Op! Verbindingsleidingen belastbaar tot maximaal 50W: Voorbeeld voor RGB-Strips: 18 Strips à 0,25 m = 4,5 m Lengte 4 Strips à 1 m = 4 m Lengte Bij langere lengtes moet men parallel voeden.
--	---

Aansluitschema RGB Strips voorbeeld met LIM® Sturing, Netvoeding 100W en interface.

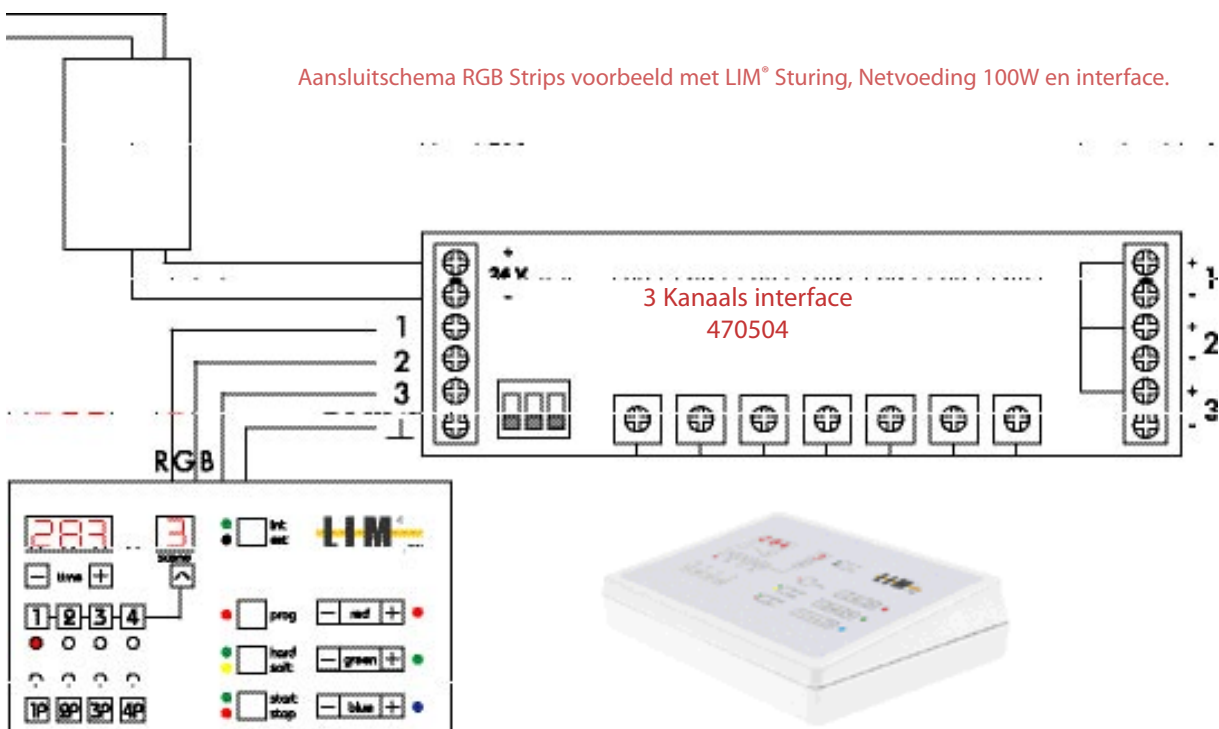



Decoratieve verlichting/ LED Strips Aansluitschema

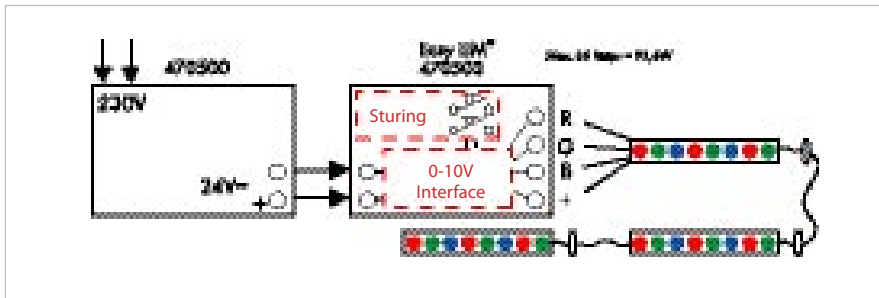

Aansluitschema met Easy LIM[®] en netvoeding

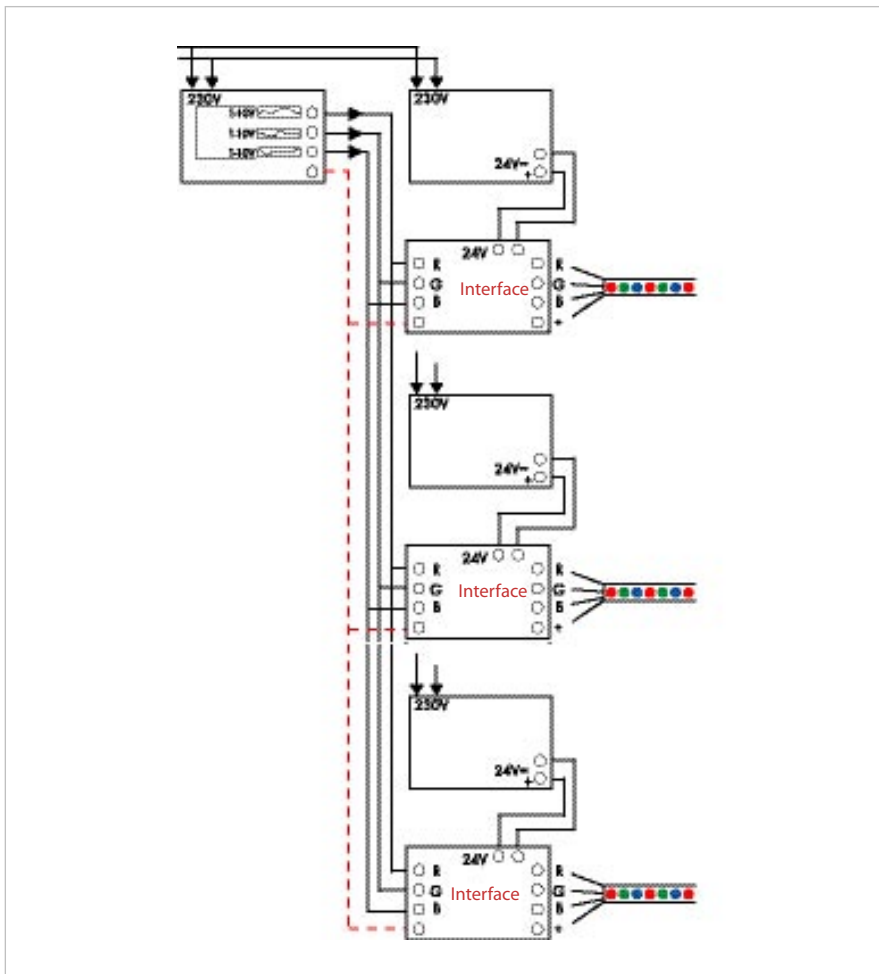

Aansluitschema van parallelschakeling bij grote vermogens.



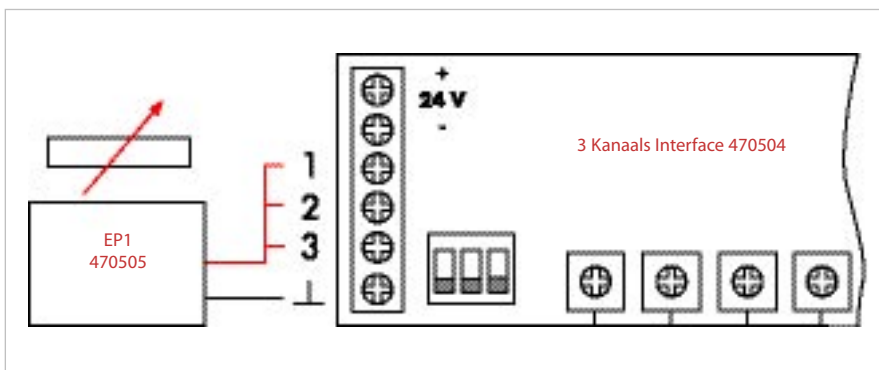

452



Aansluitschema voor 3 Kanaals interface met EP1

Gedetailleerde technische informatie over het thema LED Strips zijn op aanvraag te verkrijgen!

Easy LIM® LED Controller

	24V= oder 12V=	31VA per kanaal			Easy LIM® LED controller 470503
				 0,05	
L/B/H: 18,5/4,5/1,9 cm					179,00 €
Met ingebouwde interface op RGB uitgangssignaal. Bij 12V= : max. 15W/kanaal Bij 24V= : max. 31W/kanaal					



Geïntegreerde PWM controller, 8 voorgeprogrammeerde programma's en tijden, memoryfunctie, aansluitmogelijkheid voor externe knoppen, aansluiting aan 12V= of 24V= netvoeding voor LED. Max. belasting 4A totaal.





LIM® Controller

	230~				LIM® 3/110 Sturing 410400
				 0,62	
L/B/H: 19/13,5/5 cm					475,00 €
1-10V, Ri<100 Ohm, Imax. 50 mA					





Het LIM® 3/110 3-Kanaals controller maakt het mogelijk kleur en lichtsterkte in te stellen welke daarna eenvoudig op te roepen zijn door middel van druktoetsen. 3 verlichtingsgroepen voor een stuurspanning van 1-10 Volt (bijvoorbeeld Fluorescentie lampen, laagvolt halogeen- of hoogvolt halogeenlampen) laten zich aansturen. Ook dynamische weergave van de ingestelde scènes is mogelijk door middel van de te kiezen "wait" en "fade" time. 4 verschillende programma's met elk 8 scènes zijn al voorgeprogrammeerd. Verdere features zijn: paniekschakeling, externe schakelingang, variabele tijdsinterval en nog veel meer. Een comfortabel systeem, waarvoor geen systeemkennis nodig is en via het bedieningpaneel door elke leek probleemloos te bedienen is.

Interface, 3 Kan van Stuurspanning op 24V(12V)-2A/Kanaal

	24V= of 12V=	2A per kanaal			Interface, 3 Kanaals 470504
				 0,1	
L/B/H: 17/4/3 cm					119,00 €
Belasting 2A max./Kanaal. Instelbaar ingangssignaal: 0-10V					

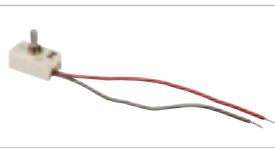
EP1 Dimmer 1-10V

		As-Ø 0,6		 0,02	EP1 Dimmerpotmeter 470505
	L/B/H1/H2: 2,3/3,9/2/3,6 cm				
11,80 €					
Voor 1-10V Sturingen.					



Accessoires/ LED Sturing 24V

Power LIM® 24V Mastersturing

	230V 24V=			Power LIM® 24V Master 470521 165,00 €
				
L/B/H: 17,5/7,8/3,5 cm. Optioneel met afstandsbediening 470520.				Voor LED producten met 24V constante spanning.
				Uitgangsvermogen 20W/uitgang, 60W max.
Geschikt voor RGB LED Strips Outdoor 229800, 229801+ 229813 en RGB LED Strips 550220 + 550225. Aansluiting van maximaal 22 RGB-LED strips. Maximaal 9 slavesturingen. 3 vaste programma's. Elke kleur kan met een knop gedimd worden. Eenvoudig gebruik.				

Power LIM® 24V Slavesturing

	230V 24V=			Power LIM® 24V Slave 470522 149,00 €
				
Aansluiting van max. 22 RGB-LED Strips incl. 1,2m stuurleiding voor verbinding met de Mastersturing.				Voor uitbreiding van Mastersturing 470521.
	L/B/H: 17,5/7,8/3,5 cm			Voor LED producten met 24V constante spanning. Uitgangsvermogen 20W/uitgang, 60W max.

Afstandsbediening voor Power LIM®

			Afstandsbediening tbv Power LIM® Mastersturingen 470521 en 470523 470520 34,90 €
			
L/B/H: 17,8/4,8/1,9 cm	Voor het aansturen van RGB-Mastersturingen 470521 en 470523.		

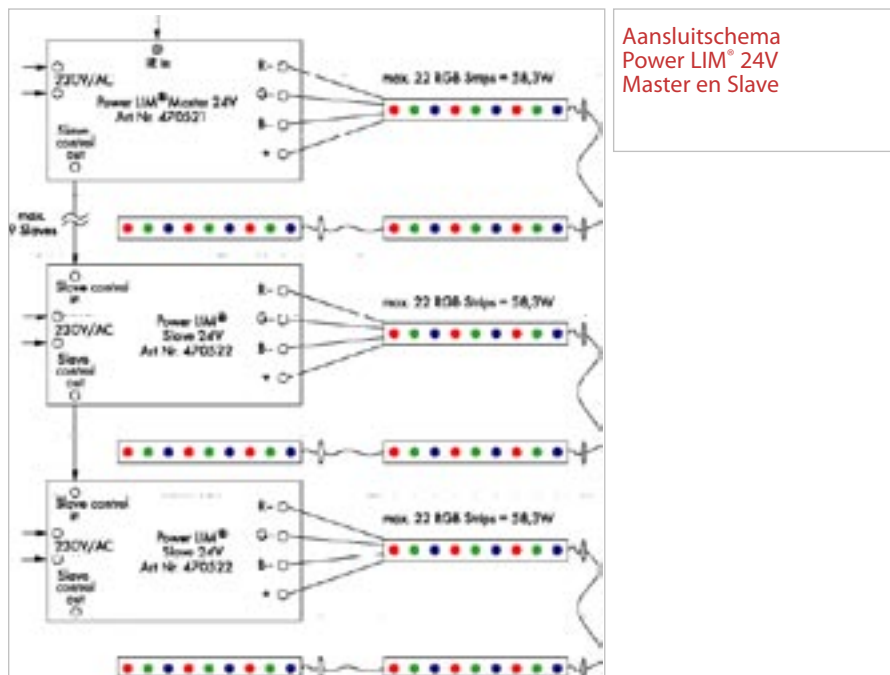









Power LIM® RGB Mastersturing 350mA

	230~ 350mA				Power LIM® RGB Master, 350mA 470523 179,00 € Met geïntegreerde Netvoeding. Voor 1W PowerLED uitgangsvermogen 7W/kanaal,
					
L/B/H: 17,5/7,8/3,5 cm. Optioneel					0,8

LED Mastersturing met geïntegreerde netvoeding. Geschikt voor gebruik van PowerLED met 350mA constante stroom. Bijvoorbeeld aansluiting van max. 5 RGB LED Frames Art.-Nr. 111263. Maximaal 9 slavesturingen 470524, waarbij de eerste twee slave sturingen de 24V spanningsvoorziening van de master sturing gebruiken kunnen. 3 voorgeprogrammeerde programma's op te halen en een vaste kleur over de druktoets in te stellen.

Power LIM® RGB Slavesturing 350mA

	24= 350mA			Power LIM® RGB Slavesturing 350mA / 21,3W 470524 149,00 € uitgangsvermogen 7W/Kanaal, 21W max. Incl. 1,2 m stuurleiding voor
				
L/B/H: 17,5/7,8/3,5 cm				0,25





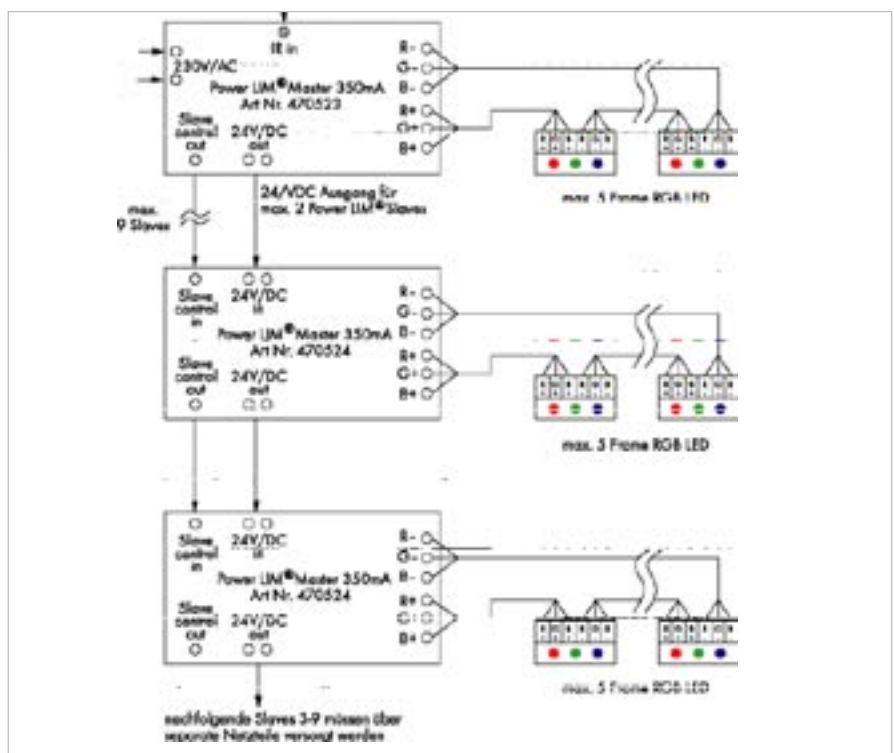

Voor uitbreiding van de mastersturing 470523 voor PowerLED met 350mA constante stroom,

Aansluitschema Power LIM® 350mA Master en Slave











Accessoires/ LED Netvoeding









Netvoeding voor LED Strips 12W

	230~ /24V=	VA 1-12			Netvoeding voor LED Strips 24V, 12W 470502 23,50 €
				 0,06	
	L/B/H: 8,5/4/2,3 cm				









Netvoeding voor LED Strips 60W

	230~ /24V=	VA 1-60			Netvoeding voor LED Strips 24V, 60W 470506 119,00 €
					
				 0,3	
L/B/H: 17,5/7,8/3,5 cm					









Netvoeding voor LED Strips 100W

	230~ /24V=	VA 1-100			Netvoeding voor LED Strips 24V, 100W 470500 129,00 €
					
				 0,62	
L/B/H: 18,2/8,8/3,5 cm					





Netvoeding voor Mini-LED-Modul-ketting 12W

	230~ /12V=				Netvoeding voor Mini-LED-Modul-Ketting 12W 12V, 12W 470507 24,90 €
					
				 0,06	
L/B/H: 8,5/4/2,3 cm					

Netvoeding voor Mini-LED-Modul-ketting 60W

	230~ /12V=				Netvoeding voor Mini-LED-Modul-ketting 60W 12V, 60W 470508 119,00 €
					
				 0,62	
L/B/H: 18,2/8,8/3,5 cm					











Aansluitbox
rond

		IP55		Aansluitbox rond zwart 229260 19,90 €		
		wartels incl.				0,25
	Ø/L/B: 11,5/15,5/15,5 cm leidings-Ø: 7-14 mm					
Geschikt voor driver 464108 bijvoorbeeld voor Power Trail-Lite						











LED Driver 3W,
350mA

		230V 350mA			LED Driver 3W, 350mA 464108 19,90 €	
		KEMA ELV				
		F				
L/B/H: 5,5/4/2 cm					Vermogen 3W (3VA) Uitgangsstroom 320mA met trekklasting Voor het aansluiten van maxi- maal 3 Power LEDs, 350mA	



LED Driver 10W,
350mA

		230V 350mA			LED Driver 10W, 350mA 464110 29,90 €	
		KEMA ELV				
		F				
Secundair aansluitsnoer max. 2m					Vermogen 1-11W met trekklasting Voor het aansluiten van max 9 Power LEDs, 350mA met connector voor stekkerzet 111850 zie hieronder.	
L/B/H: 16,5/4/3 cm						

LED Driver 18W,
350mA

		230V 350mA			LED Driver 18W, 350mA 464111 79,90 €	
		KEMA ELV				
		F				
L/B/H: 14/6,8/3,5 cm					Vermogen 18W max. Met trekklasting Voor het aansluiten van maxi- maal 15 Power LEDs, 350mA. Met connector voor stekkerzet 111850 zie hieronder.	

Verdeelblok

		0,015		Verdeelblok 111850 5,95 €
	L/B/H: 5,2/1,4/1,3 cm			
max. stroombelasting 350mA Serieschakeling 3 uitgangen, incl. extra connec- tor (indien er minder dan 3 LEDs aangesloten worden)				